

INSTALLATION INSTRUCTIONS FOR RCQD COILS

R-410A
earth friendly refrigerant



RECOGNIZE THIS SYMBOL AS AN INDICATION OF IMPORTANT SAFETY INFORMATION!

WARNING

THESE INSTRUCTIONS ARE INTENDED AS AN AID TO QUALIFIED, LICENSED SERVICE PERSONNEL FOR PROPER INSTALLATION, ADJUSTMENT AND OPERATION OF THIS UNIT. READ THESE INSTRUCTIONS THOROUGHLY BEFORE ATTEMPTING INSTALLATION OR OPERATION. FAILURE TO FOLLOW THESE INSTRUCTIONS MAY RESULT IN IMPROPER INSTALLATION, ADJUSTMENT, SERVICE OR MAINTENANCE POSSIBLY RESULTING IN FIRE, ELECTRICAL SHOCK, PROPERTY DAMAGE, PERSONAL INJURY OR DEATH.



ISO 9002

DO NOT DESTROY THIS MANUAL

PLEASE READ CAREFULLY AND KEEP IN A SAFE PLACE FOR FUTURE REFERENCE BY A SERVICEMAN

TABLE OF CONTENTS

Model Number Explanation	2
Unit Specifications	3
Airflow Pressure Drop	4
Coil Application	5
INSPECTION	5
GENERAL INFORMATION	5
Codes/Regulations	5
Replacement Parts	5
INSTALLATION	6
Vertical Upflow/Downflow	6
Horizontal	6
Refrigerant Connections	7
Horizontal Drain Pan Extension	7
TXV Sensing Bulb	7
Condensate Drain Tubing	7
MAINTENANCE	8
Air Filter	8
Indoor Coil	8
ACCESSORIES	8
Plenum Adapter Accessory	8

FIGURE 1
MODEL NUMBER EXPLANATION

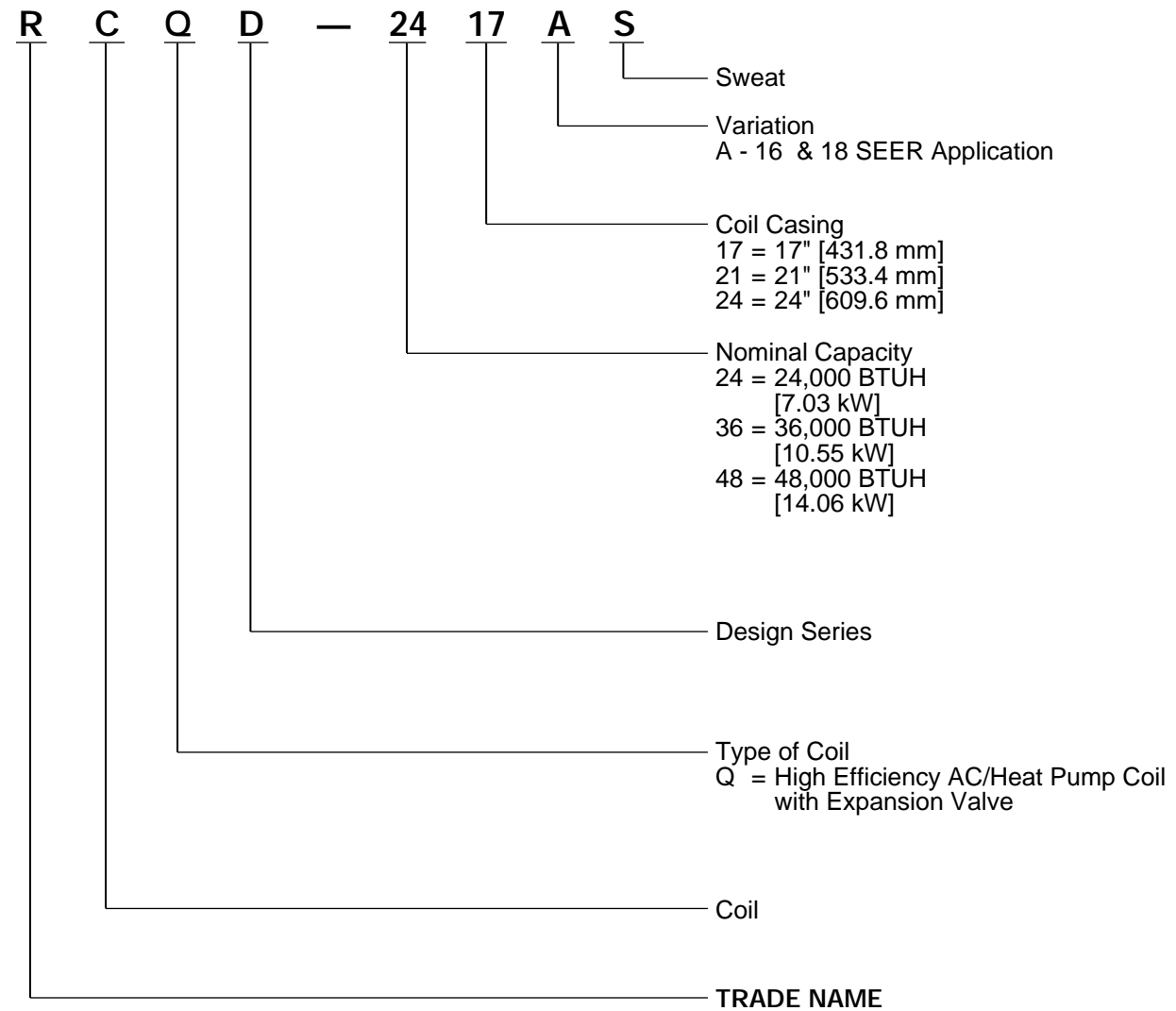

**FIGURE 2
UNIT SPECIFICATIONS**

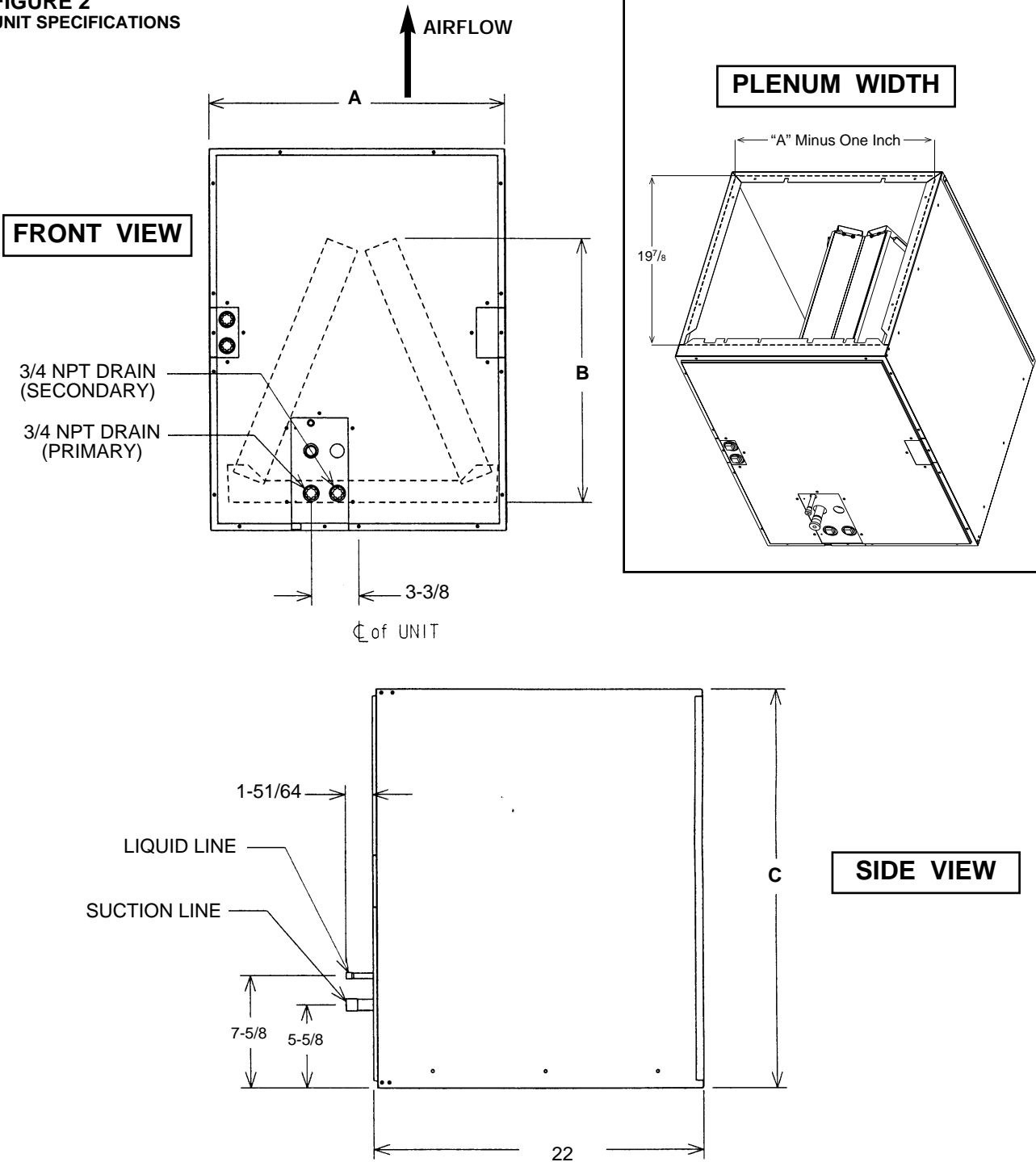

DIMENSIONS AND WEIGHTS DATA

Coil Model Number	Connections		Dimensions (in.) [mm] – Weight (lbs.) [Kg]				
	Sweat (in.) [mm]		A	B	C	Coil Weight (lbs.) [Kg]	Shipping Weight (lbs.) [Kg]
	Liquid I.D.	Suction I.D.					
RCQD-2417AS	3/8 [9.53]	3/4 [19.05]	17-1/2 [445]	19-7/8 [505]	28 [711]	59 [27]	67 [30]
RCQD-3621AS	3/8 [9.53]	7/8 [22.23]	21 [533]	24-3/4 [629]	28 [711]	74 [34]	83 [38]
RCQD-3624AS	3/8 [9.53]	7/8 [22.23]	24-1/2 [622]	24-3/4 [629]	28 [711]	80 [36]	90 [41]
RCQD-4821AS	3/8 [9.53]	7/8 [22.23]	21 [533]	24-3/4 [629]	28 [711]	74 [34]	83 [38]
RCQD-4824AS	3/8 [9.53]	7/8 [22.23]	24-1/2 [622]	24-3/4 [629]	28 [711]	80 [36]	90 [41]

TABLE 1
COIL SPECIFICATIONS / AIRFLOW PRESSURE DROP

Model Number RCQD-	Type Air Flow ①	Approx. Design Air Flow CFM [L/s] Range	Face Area Sq. Ft. [m²]	Fins-in. Rows Deep	Static Pressure Drop Through Wet Cooling Coil [kPa] (Inches H ₂ O) CFM [L/s]											
					600 [283]	700 [330]	800 [378]	900 [425]	1000 [472]	1100 [519]	1200 [566]	1300 [614]	1400 [661]	1500 [708]	1600 [755]	1700 [802]
HIGH EFFICIENCY COOLING COILS																
2417AS	U-H	450/800 [212/378]	4.38 [0.41]	14/3	0.06 [.015]	0.10 [.024]	0.14 [.035]	0.17 [.042]	0.21 [.052]	0.25 [.062]	0.29 [.072]					
3621AS	U-H	720/1200 [340/566]	5.83 [0.54]	14/3			0.08 [.02]	0.10 [.025]	0.13 [.032]	0.16 [.04]	0.18 [.045]	0.21 [.052]				
3624AS	U-H	720/1200 [340/566]	5.83 [0.54]	14/3			0.07 [.017]	0.09 [.022]	0.11 [.027]	0.13 [.032]	0.15 [.037]	0.17 [.042]				
4821AS	U-H	960/1600 [453/755]	5.83 [0.54]	14/3					0.14 [.035]	0.17 [.042]	0.19 [.047]	0.22 [.055]	0.25 [.062]	0.29 [.072]	.032 [.08]	
4824AS	U-H	960/1600 [453/755]	5.83 [0.54]	14/3					.11 [.027]	.13 [.032]	.15 [.037]	.17 [.042]	.19 [.047]	.23 [.057]	.25 [.062]	

①H = Horizontal airflow, U = Upflow

**TABLE 2
COIL APPLICATION**

Coil Model RCQD	Type Air Flow*	Furnace Width inches [mm]		Plenum Adapter Upflow
		Oil	Gas	
2417AS	U-H	21 [533]	17-1/2 [445]	N/A
	U-H		14 [356]	RXBA-AC
3621AS	U-H	21 [533]		N/A
	U-H		21 [533]	N/A
	U-H		17-1/2 [445]	RXBA-AC
4821AS	U-H		21 [533]	N/A
	U-H		17-1/2 [445]	RXBA-AC
3624AS, 4824AS	U-H	24-1/2 [622]		N/A
	U-H		24-1/2 [622]	N/A
	U-H		21 [533]	RXBA-AC

NOTES:

* U = UPFLOW

H = HORIZONTAL

▲ WARNING

PROPOSITION 65: THIS APPLIANCE CONTAINS FIBERGLASS INSULATION. RESPIRABLE PARTICLES OF FIBERGLASS ARE KNOWN TO THE STATE OF CALIFORNIA TO CAUSE CANCER.

All Rheem products meet current Federal OSHA Guidelines for safety. California Proposition 65 warnings are required for certain products, which are not covered by the OSHA standards.

California's Proposition 65 requires warnings for products sold in California that contain or produce any of over 600 listed chemicals known to the State of California to cause cancer or birth defects such as fiberglass insulation, lead in brass, and combustion products from natural gas.

All "new equipment" shipped for sale in California will have labels stating that the product contains and/or produces Proposition 65 chemicals. Although we have not changed our processes, having the same label on all our products facilitates manufacturing and shipping. We cannot always know "when, or if" products will be sold in the California market.

You may receive inquiries from customers about chemicals found in, or produced by, some of our heating and air-conditioning equipment, or found in natural gas used with some of our products. Listed below are those chemicals and substances commonly associated with similar equipment in our industry and other manufacturers.

- Glass Wool (Fiberglass) Insulation
- Carbon Monoxide (CO).
- Formaldehyde
- Benzene

More details are available at the websites for OSHA (Occupational Safety and Health Administration), at www.osha.gov and the State of California's OEHHA (Office of Environmental Health Hazard Assessment), at www.oehha.org. Consumer education is important since the chemicals and substances on the list are found in our daily lives. Most consumers are aware that products present safety and health risks, when improperly used, handled and maintained.

I. INSPECTION

Immediately upon receipt, all cartons, and contents should be inspected for transit damage. Units with damaged cartons should be opened immediately. If damage is found, it should be noted on the delivery papers and a damage claim filed with the last carrier.

- After unit has been delivered to job site, remove carton taking care not to damage unit.
- Check the unit rating plate to be sure equipment matches what is required for the job specification.
- Read the entire instructions before starting the installation. This is particularly important if this is the first installation for this specific model series.
- Many installation steps done prior to setting the unit in place can save time and simplify the installation.

II. GENERAL INFORMATION CODES/REGULATIONS

Units should be installed in accordance with any local code which may apply and the national codes. Latest editions are available from: "National Fire Protection Association, Inc., Batterymarch Park, Quincy, MA 02269." These publications are:

- *ANSI/NFPA Latest Edition (NEC) National Electrical Code.*
- *NFPA90A Installation of Air conditioning and Ventilating Systems.*
- *NFPA90B Installation of Warm Air Heating and Air Conditioning Systems.*

REPLACEMENT PARTS

Any replacement part must be the same as or an approved alternate to the original part supplied. The manufacturer will not be responsible for replacement parts not designed to physically fit or operate within the design parameters the original parts were selected for.

When ordering replacement parts, it is necessary to order by part number and include the complete model number and serial number from the unit rating plate. (See parts list for unit component part numbers.)

III. INSTALLATION

COIL INSTALLATION

▲ CAUTION

WHEN INSTALLING A UNIT WITH COOLING COIL OVER A FINISHED CEILING AND/OR LIVING SPACE, INSTALLATION OF A SECONDARY FIELD FABRICATED DRAIN PAN UNDER THE ENTIRE UNIT, TO AVOID DAMAGE TO CEILING, IS RECOMMENDED.

RCQD- coils can be applied in various upflow and horizontal flow configurations. (See Figure 3. Refer to Table 2 for approved applications).

▲ CAUTION

FOR HORIZONTAL APPLICATIONS, THE HORIZONTAL DRAIN PAN MUST BE LOCATED UNDER THE INDOOR COIL. FAILURE TO PLACE THE PAN UNDER THE COIL CAN RESULT IN PROPERTY DAMAGE.

VERTICAL UPFLOW AND HORIZONTAL LEFT INSTALLATION

(SEE FIGURE 3)

1. For vertical or horizontal left installation, no modification from current factory configuration is required.
2. Seal the gap around the refrigerant lines with the permagum provided in the parts bag.

NOTE: The coil is shipped from factory for the vertical or horizontal left position. The coil must be converted for use in horizontal right position.

VERTICAL DOWNFLOW

IMPORTANT: The RCQD-series coil is not approved for vertical downflow applications.

▲ CAUTION

SEVERE CONDENSATE BLOWOFF CAN OCCUR IF THE RCQD COIL IS APPLIED IN A VERTICAL DOWNFLOW APPLICATION.

FIGURE 3
FACTORY SHIPPED COIL INSTALLATION



HORIZONTAL LEFT

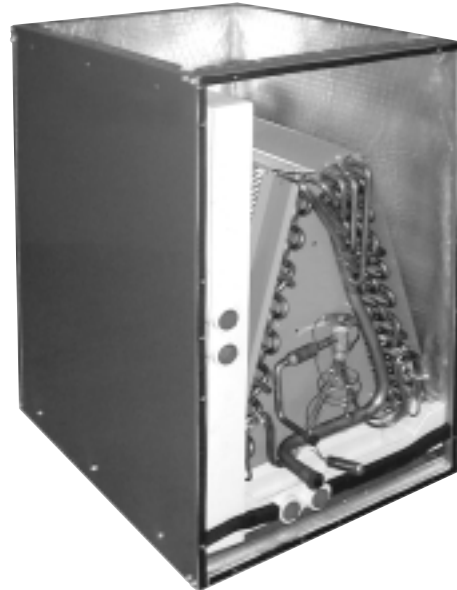

UPFLOW

FIGURE 4
HORIZONTAL RIGHT INSTALLATION



HORIZONTAL LEFT INSTALLATION

All RCQD-series coils are shipped for vertical and horizontal left applications. Conversion is required for horizontal right applications.

HORIZONTAL RIGHT INSTALLATION

(SEE FIGURE 4)

THE FOLLOWING COIL MODIFICATIONS MUST BE IMPLEMENTED:

1. Remove the entire front panel assembly by removing all necessary screws.
2. Remove the refrigerant access panel from the front panel and reinstall it with the right-hand side mounting holes (see Figure 5).
3. Switch the positions of the left condensate plate and right blank plate on the front panel.
4. Slide the coil outside of the coil box.
5. Remove the vertical bracket on the right side of the vertical drain pan (see Figure 6).
6. Remove the horizontal drain pan and place it on the right side of the coil (see Figure 7).
7. Re-install the vertical bracket on the left side of the vertical drain pan.
8. Remove all screws from the top of the air stop (see Figure 8).
9. Remove the center drain trough by removing the screw located at the back triangular plate (see Figure 8). Ensure glue stop on the bottom of the drain trough.
10. Rotate the center drain trough 180°, front to back (see Figure 9).

NOTE: Failure to properly rotate the center drain trough may permit condensate water to blow off the cooling coil.

11. Apply permagum supplied in parts bag to underside of drain trough (see Figure 10) in four corners.
12. Re-install the center drain trough and secure it by tightening the screw through the hole located on the front triangular plate. Reinstall the top air stop.
13. Replace the coil assembly into the coil box (be sure to align the vertical brackets properly with the side rail), taking care not to tear insulation.
14. Locate TXV sensing bulb and slide it through the universal grommet on the access panel.
15. Reinstall front panel.
16. Seal the gap around the refrigerant lines with the permagum provided in the parts bag.

REFRIGERANT CONNECTIONS

Keep the coil connections sealed until refrigerant connections are to be made. See the Installation Instructions for the outdoor unit for details on line sizing, tubing installation, and charging information.

Install refrigerant tubing so that it does not block service access to the front of the unit.

Use a brazing shield to protect the cabinet's paint from being damaged by torch flames.

Coil is shipped with a low (5 - 10 PSIG) pressure charge of dry nitrogen. Evacuate the system before charging with R-410A refrigerant.

FIGURE 5
REFRIGERANT ACCESS PANEL

NOTE: WHEN CONVERTING TO HORIZONTAL RIGHT INSTALLATION, USE THE RIGHT-HAND SIDE MOUNTING HOLES IN THE REFRIGERANT ACCESS PANEL

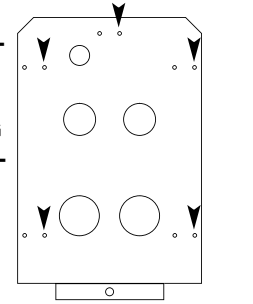

TXV SENSING BULB

IMPORTANT: Do not perform any brazing with the TXV bulb attached to the line.

After brazing operations have been completed, clamp the TXV bulb securely on the suction line at the 2 o'clock position with the strap provided in the parts bag.

Insulate the TXV sensing bulb and suction line with the provided pressure sensitive insulation (size 4" x 7") and secure with provided wire ties.

NOTE: TXV sensing bulb should be located on a horizontal section of suction line, just outside of coil box.

CONDENSATE DRAIN TUBING

Consult local codes or ordinances for specific requirements.

IMPORTANT: When making drain fitting connections to drain pan, use a thin layer of teflon paste, silicone or teflon tape and install hand tight.

IMPORTANT: When making drain fitting connections to drain pan, do not overtighten. Overtightening fittings can split pipe connections on drain pan.

- Do not reduce drain line size less than connection size provided on condensate drain pan.
- All drain lines must be pitched downward away from the unit a minimum of 1/8" per foot of line to ensure proper drainage.
- Do not connect condensate drain line to a closed or open sewer pipe. Run condensate to an open drain or outdoors.
- The drain line should be insulated where necessary to prevent sweating and damage due to condensate forming on the outside surface of the line.
- Make provisions for disconnecting and cleaning of the primary drain line should it become necessary. Install a 2 in. trap in the primary drain line as close to the unit as possible. Make sure that the top of the trap is below connection to the drain pan to allow complete drainage of pan (see Figure 5).

FIGURE 6
VERTICAL BRACKET

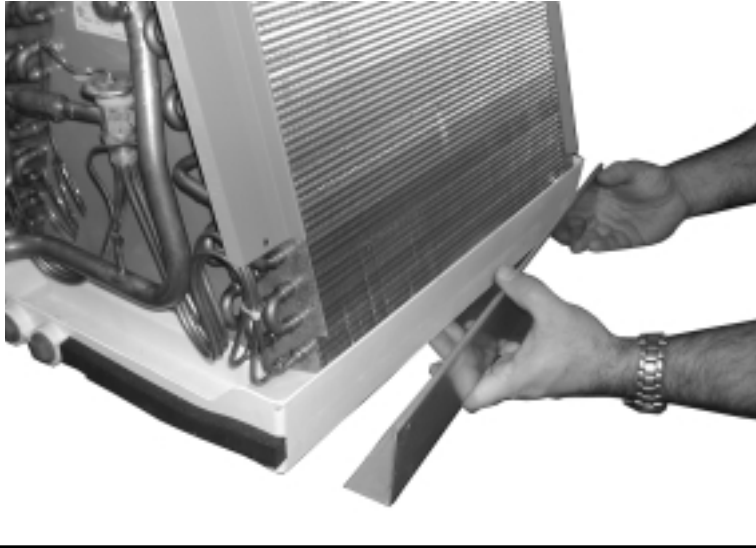

FIGURE 8
AIR STOP
SCREWS

SCREW
REMOVAL

DRAIN
TROUGH
SCREW

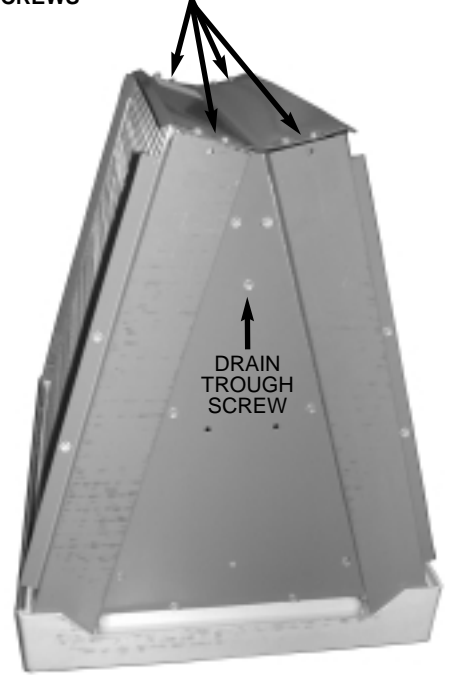

FIGURE 7
DRAIN PAN PLACEMENT



FIGURE 9
ROTATE DRAIN TROUGH

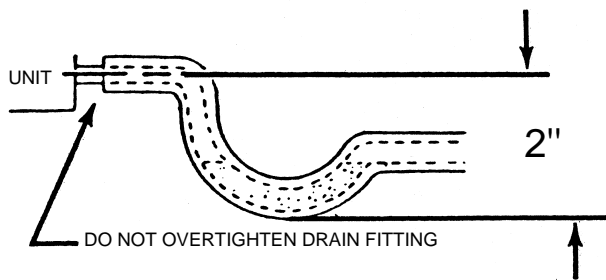

FIGURE 10
PERMAGUM APPLICATION



FIGURE 11
CONDENSATE DRAIN TRAP

**DO NOT OPERATE UNIT WITHOUT
CONDENSATE DRAIN TRAP.**



**UNIT MUST BE SLOPED
TOWARD DRAIN CONNECTION.**

- Auxiliary drain if used should be run to a place where it will be noticeable if it becomes operational. Occupant should be warned that a problem exists if water should begin running from the auxiliary drain line.
- Test condensate drain pan and drain line after installation is complete. Pour several quarts of water into drain pan, enough to fill drain trap and line. Check to make sure drain pan is draining completely, no leaks are found in drain line fittings, and water is draining from the termination of the primary drain line.

V. ACCESSORIES

PLENUM ADAPTER ACCESSORY RXBA-AC

This plenum adapter accessory is for installation on cased indoor cooling and heat pump coils. This allows a nominal size cased coil to be installed on the next smaller size gas or oil furnace. **NOTE: This accessory is for installation on coil casings to fit gas or oil furnaces only - this accessory must not be used on electric furnaces or heat pump air handlers.** Consult the installation instructions packaged with the accessory for proper installation. The RXBA-AC (upflow) can be ordered factory installed by designation as "with adapters" in the coil model number.

PLENUM ADAPTER ACCESSORY RXBA-AE

This plenum adapter accessory is for use with the 24-1/2" wide cased indoor cooling and heat pump coils. This allows a 24-1/2" wide cased coil to be installed on a 28" wide oil furnace. This is a field installed accessory only.

